

# ST. ANDREW WEEKLY NEWS

March 17, 2024

St. Andrew Lutheran Church  
12405 SW Butner Road, Beaverton, OR 97005

Worship Service:  
Sunday, 9:30 am

[www.standrewlutheran.com](http://www.standrewlutheran.com) ■ Telephone: 503-646-0629

## Spirituality Book Group News

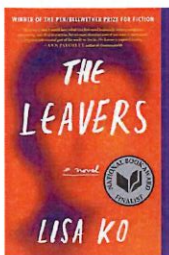

The Spirituality Book Group will meet at Dianne Zupunski's home on **Sunday, March 17**, to discuss *The Leavers*, by Lisa Ko. The book received the 2016 PEN/Bellwether Prize for Fiction, awarded by Barbara Kingsolver to a novel that addresses issues of social justice. It was also a finalist for the National Book Award in 2017 and was described by Ann Patchett as "beautifully written, ambitious, and moving."

*The Leavers* is the story of an undocumented immigrant child adopted by well-meaning white professors after his Chinese mother disappears. It examines issues of borders and belonging, of a boy coming into his own after everything he loves is taken away, and of the adopting mother who must learn how to live with past mistakes.

Date/Time: **Sunday, March 17**, 3:00 pm  
Book: *The Leavers*, by Lisa Ko  
Hostess: Dianne Zupunski  
Discussion Leader: Sharon Fako

All are welcome. Call Mary Smith at 503-332-9732 for more information.

### Future Reading:

**April 14:** *A Tale for the Time Being*, by Ruth Ozeki  
Hostess: Sharon Fako  
Discussion Leader: Mary Smith

**May (date TBA)** *We Have Always Been Here*, by Samra Habib\*  
Hostess: TBA  
Discussion Leader: Elaine May

\*Book now available in church library.

## New Directory!

If you have an email address on file with St. Andrew, you received a "Connect Card" last week from the church office. Please take the time to fill it out and email it back to the church by March 31. This is the first step in creating an updated directory, something that we badly need. Specifically, open your email and

1. Download the "Connect Card."
2. Open the document (from your downloads folder).
3. Fill in your information.
4. Save the document to your computer.
5. Attach that same document to an email and send to: [office@standrewlutheran.com](mailto:office@standrewlutheran.com).

If you do not have an email address, we have mailed you the "Connect Card." Please fill it out legibly and drop it in the offering plate or mail it to the church. See the address included in the newsletter masthead.

## Help Write Postcards to Potential Voters

2024 is another Presidential election year and this year's vote is expected to be a crucial one. Given the expected candidate choices, many people are planning not to vote at all. Liz Hardy and Jan Smith have contacted several organizations that encourage first-time voters or those who typically do not vote to do so this year.



St. Andrew has participated in campaigns like this before. Our 2024 effort includes both primary elections and the general election on November 5, so we'll be writing postcards between now and November.

Already, thousands of postcards have been sent to North Carolina voters whose primary election was on March 5. These cards were from the Environmental Voter Project, and the message sent was, "I know you are a good voter. Please make sure your friends and family are good voters too!" Mind you, these cards were sent to people who are concerned about the environment, but do not typically vote. Whether or not a person votes is public record, but how they vote is not known.

Jan and Liz are looking for a team of people to send encouraging messages to potential voters. No specific postcard or letter-writing dates have been scheduled, but they will be soon. Many of you wrote postcards to Georgia voters in 2020, and to Arizona, Massachusetts, Pennsylvania, and Georgia in 2022. This will be a similar effort. We will have training sessions and volunteers will be able to take groups of 20 cards or letters to fill out and send by specific dates. Voter turnout organizations will provide a list of voters to contact and a suggested script to use.

If you would like to write to voters, please contact Liz or Jan so we can create our team. Thank you!

*Jan Smith and Liz Hardy*

## Photo Signups for Church Directory

Both before and after worship this **Sunday, March 17**, people are invited to sign up to have their photos taken for the 2024 Church Directory. Please see Lisa Staul in the Narthex to reserve your time. Photos will be taken **Wednesday-Friday, May 8-10**, 2:00 - 8:30 pm. Participants will receive a complimentary 8 x 10 portrait and a spiral-bound directory when they become available. They will also have the opportunity to purchase additional photos (\$25 for an 8 x 10), but are not required to do so.

Who should sign up? You should! Church membership is not a requirement to be included in the directory. If you participate in this faith community in any way, you belong in the book.

This new directory is much-needed and will help our new pastor get to know the people of St. Andrew. Although photo signups will continue for six weeks, remember that those who sign up early will get their choice of times. Early signups are appreciated!

Observing and Celebrating

# LENT WITH ST. ANDREW

Midweek Lenten Services 7 pm  
Mar 20: Communal Lament (Mary Smith)

March 24, 2024 - Palm Sunday  
Service at 9:30 am

March 28, 2024 - Maundy Thursday  
Service at 7 pm

March 29, 2024 - Good Friday  
Service at 8 pm

March 31, 2024 - Easter Sunday  
Service at 9:30 am

## Tree Talk: Insect Pests that Bug Our Trees



Emerald Ash Borer

While most insects are beneficial, some bugs can cause big problems when trees become stressed. Join Christine Buhl, PhD, forest entomologist with the Oregon Department of Forestry, at 6:00 pm in Fellowship Hall next Wednesday, March 20, when she will review some of the major native and exotic insect pests that affect our Washington County trees.



Damage caused by the Emerald Ash Borer

After years of wreaking their damage elsewhere, both the recently discovered Mediterranean Oak Borer and Emerald Ash Borer have been found in Oregon and could threaten our urban and forest trees. Find out what they are, how to identify them, and how to prevent them from spreading.

This will be a hybrid event. Sign up to attend in person here:

<https://tinyurl.com/5hfv79b9>

If you plan to attend by Zoom, please use the following link to register:

<https://tinyurl.com/587pvxsp>



## A Report from The Roots

The Church Mouse has been nosing around St. Andrew on Sunday mornings (as church mice sometimes do)! She noticed a small bunch of grade school kids having a great time on St. Andrew's lower level. They were learning about the Bible from some wonderful teachers by playing games, doing art work, listening to stories, and a bunch of other things. They learned the science behind how the Red Sea could have receded, how to wrap Lazarus up as a mummy and watch him come alive, how to produce a beautiful cross with lovely papers and glue. It's all happening in The Roots! Adults are always welcome to watch, participate, or bring their youngsters. There are places for all almost every Sunday, 11:00 am-12:00 pm. **(Please Note: No Roots on Palm Sunday or Easter Sunday)**

## Night of Stories!

I am so excited to announce a brand new, community-focused event for younger adults, **Night of Stories!** This monthly event is a cooperative effort between three organizations: St Andrew, The Repentant Church (a recent start-up through the United Methodist Church), and also the Portland-based storytelling nonprofit Ghost Light PDX. The first iteration of Night of Stories will be hosted on Sunday, March 24, 6:00 - 8:00 pm, at **Grinds and Vines** coffee shop in Portland. The theme for the night is "The Thousand Word Picture Show." Plans include a photo booth, caption contest, featured storytellers, live music, and the chance for you to share stories of your own in a safe, fun, and casual environment. No preparation is needed to attend; just come as you are!



Grinds and Vines  
3520 SW Yamhill St  
Portland, OR 97214

To understand the vision for this event, check out our opening creed:

Maybe. Just maybe. There's nothing more human than to tell a story.

From that night, thousands of years ago,  
when cavemen sat around that very first campfire,  
looking up at the stars in wonder,  
telling each other jokes...

To the stories we tell in quiet reverence,  
when we gather together to grieve a loved one lost.  
To be human is to tell stories.

Even when we sleep, our brain is up all night telling us  
stories in the form of dreams.

Friends, our desire is to be a beautiful and weird experiment.

To share our stories with each other,  
whether they are tales of wonder or woe,  
the sacred or profane,  
soul stirring or just plain weird.

But most of all:

We share stories with each other, so that maybe, just maybe,  
we might come to see ourselves,  
see each other,  
and see this weary little world of ours,  
as cherished works of art.

In February we hosted a small test run of the event with about 16 people, all under the age of 35, and it was a huge hit! We are so excited to open it up for this official launch. To learn more about Night of Stories, find us on Instagram @NightOfStoriesPDX. You can also email me at [kvogt@standrewlutheran.com](mailto:kvogt@standrewlutheran.com) or contact [NightOfStories-PDX@gmail.com](mailto:NightOfStories-PDX@gmail.com). Don't forget to follow us, and make sure to invite your friends! We'll see you there!

Kyler Vogt

Director of Next Generational Ministry

## Wednesday Book Group

St. Andrew's Wednesday afternoon Book Group began a new book on March 13: *Devotional Classics*, by Richard Foster and James Bryan Smith. Led by Sister India, the group will be reading writings from spiritual thinkers, including C.S. Lewis, Julian of Norwich, and Gregory of Nyssa. Meetings are held in the St. Andrew Room on Wednesdays, 1:00-2:30 pm.

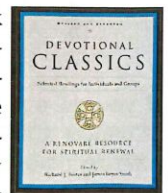

## Easter Sunday Brunch



St. Andrew will celebrate Easter during worship at 9:30 am on **Sunday, March 31**, with a brunch to follow in Fellowship Hall. Plan to bring your family and guests to join in the festivity.

Just as in years past, St. Andrew will rely on people from the congregation to bring pastries, fruit or vegetable trays, small sandwiches, hard-boiled or deviled eggs, and other appropriate brunch fare. We hope you'll be able to attend.

## Wrestling with the Truth of Colonization

Wrestling with the Truth of Colonization is an 8-session training designed for members of labor, community, and faith organizations who are interested in learning about the history of colonization and its lingering impact on our world today. Last year, 10 members of our St. Andrew community participated in this training. You are invited to join this year's sessions in reflection and learning around the truth of colonization and its ongoing impact in the region where we live. To learn more and to register, go to:

<https://tinyurl.com/msz4rkb>

Please confirm that you are able to attend all of the sessions (introductory training and Zoom sessions) before registering, as each session builds on the learnings of the previous sessions.



### "Wrestling" Sessions

#### Introductory Briefings:

All participants must attend ONE of the following two introductory briefings in order to participate in the Wrestling Training:

Intro Briefing Option 1: **Monday, April 1**, 12:00pm-12:30 pm PST

Intro Briefing Option 2: **Tuesday, April 2**, 6:00 pm-6:30 pm PST

#### First Five Sessions:

##### Tuesday and Thursday Evenings

Dates: Tuesday & Thursday nights: April 4, 9, 11, 16, and 18

Time: 6:00-8:00 pm PST

The first five sessions listed above will be held over Zoom. The Zoom link will be provided upon registration.

#### Last Three Sessions:

The last three sessions will be spaced out over three months and designed to continue each individual's personal wrestling, dig into local histories and experiences of Indigenous peoples, and identify action opportunities.



#### Cost and Registration Deadline:

Like all of our trainings, this one is free to members of MACG member institutions. There are also slots available for non-member institutions. The full training cost to non-members is \$250/person, with a sliding scale available to support access. Please contact Riley ([admin@iafnw.org](mailto:admin@iafnw.org)) to see about availability of open non-member slots. The registration deadline for this event is **Monday, April 1, at midnight PST.**

Questions? Contact any member of the St. Andrew Connections Team (formerly MACG Core Team): Gretchen Bancroft, Larry Bliesner, Pat Christiansen, Lynn Santelmann, and Jan Smith.

## Silk-Dyed Easter Egg Workshop

**Saturday, March 30**

9:00 am—Noon

St. Andrew Room and Kitchen



Transferring patterns from silk onto eggs is an art you can learn.

Remember those beautiful, intricately dyed eggs at last year's Easter brunch? Join Libby Calhoun on **Saturday, March 30**, to learn this easy, yet elegant, craft. Please sign up in the Narthex.

Participants will need to provide 1 dozen RAW eggs. White works best for color transfer, but brown eggs also can be used. We ask that you plan to leave a few eggs for St. Andrew's Easter brunch, but you'll take most of them home for your own Easter celebration.

We are also collecting 100% silk scarves, printed ties, and fabrics—the more patterned the better—to make our designs. Please note that 100% silk is needed for the magic to work and that any silks you provide are non-returnable. Please leave your contributions in the Easter basket by the signup sheet.

Learn this beautiful craft and then refresh your soul by walking the labyrinth in Fellowship Hall. If you have questions, please call Libby at 503-640-5557.

## The Labyrinth on Holy Saturday

On **Holy Saturday, March 30**, from 10:00 am-

1:00 pm, St. Andrew will again host Westminster Presbyterian's labyrinth. We will gather to reflect on the time before our Lord rose on Easter Sunday. Calming music will facilitate your meditation. Please bring writing materials for journaling if that would be useful for reflection. If you have questions, please contact Sister India (email [india@standrewlutheran.com](mailto:india@standrewlutheran.com)).



## Lenten Food Train Chugging Along

Let's fill those

boxcars!



The engine is revved up and hauling more and more boxcars of food and hygiene products destined for the St. Matthew Food Bank. Continuing through Lent, we hope to fill multiple boxes to feed the hungry and help the needy in our community.

The train is wending its way around the Narthex. Please bring non-perishable food items (such as canned corn, spaghetti and spaghetti sauce, sugar, rice, and beans) as well as hygiene products (shampoo, toothbrushes, toothpaste, and deodorant) to fill the boxcars.

If you prefer to donate money, you may write a check with Lenten Food Drive on the memo line or go [online](#) and select Lenten Food Drive from the drop-down menu to make your gift electronically. Every \$250 donated will add a new boxcar to the train.

With inflation continuing to impact people's ability to purchase daily necessities, this is a critical time for those in need around us. Your donations will make a big difference. **Get on board and let's see where this train will take us!**

## Worm Bin Construction

From Master Recycler Handbook

As promised last week, here are instructions to make your own worm bin.

### Wood Worm Bin:

Used mostly for fruit and vegetable trimmings and kept outside as compost "tea" will drain out of the bottom. The bin may require occasional watering. This bin also doubles as a seat. Basic carpentry skills are needed.

#### Materials:

1 - 4x4 foot 1/2" exterior grade non-treated plywood

3 - 6 foot 2x2s

1 - 4 foot 2x4

1 lb 4-penny galvanized nails

2 - 1/2" wood screws

2 - 2" hinges with Cd screws

1 - Solvent-free, low VOC, waterproof wood glue

**Tools:** saw, hammer, measuring tape, square, drill w/ 1/4" and 3/32" bits, sandpaper

#### Assembly:

Glue all wood pieces before nailing.

**Base:** Nail two 23" 2x4s and two 19 7/8" 2x2s to the bottom of 23" x 23" plywood as shown. Drill at least 24 1/4" holes for drainage.

**Sides:** Nail the four 2x2 uprights to the 2 side walls along the 11 3/4" edge, with one end of each 2x2 flush with the top edge of the walls. Nail a 19 7/8" 2x2 hinge support to the top edge of the back wall piece, leaving a 1 1/2" on each side for 2x2 uprights. Assemble box by nailing the 1 1/4" overhang of the side walls to the 2x2s on the base as drawn. Nail the front and back walls to the 2x2 uprights and to the 2x4s on the base as drawn. Be sure the hinge support is at the top of the bin.

**Lid:** Nail lid together as drawn. Attach to box with hinges, making sure to pre-drill screw holes into the 2x2s and position hinges as drawn. Attach chain with 1/2" wood screws so lid can rest in opened position.

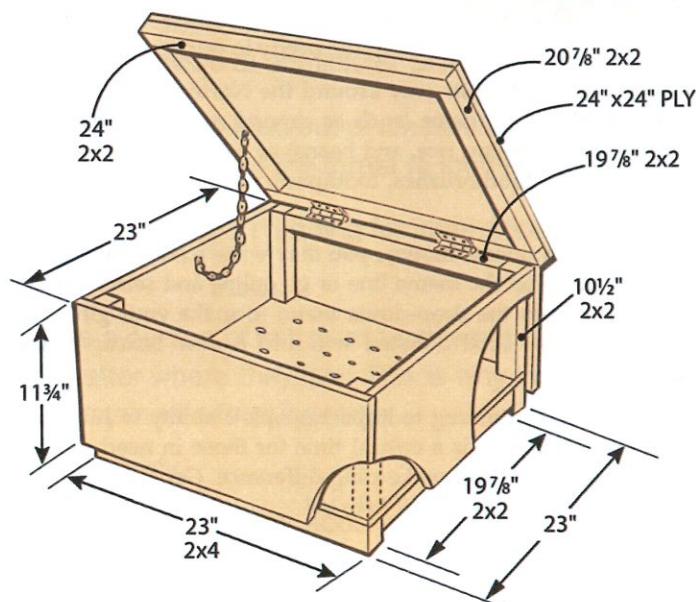

### Plastic Worm Bin for Indoors:

Used mostly for fruit and vegetable trimmings. It is very easy to build and tidy for indoor use. The plastic bins keep compost moist and will require regular additions of dry bedding such as shredded newspaper.

#### Materials:

2 plastic storage containers measuring 12"-18" tall and 12"-24" base with 1 tight-fitting lid and a drill with 1/4" and 3/32" bits. If you use it outdoors, you only need 1 storage container. The second bin is to collect drainage.

#### Assembly:

Drill at least 6 holes per side for ventilation about 1/2 to 3/4 of the way up the sides of the bin. Drill at least 12 1/4" holes for drainage in the bottom of one bin. Place the bin with the holes in the bottom inside the bin without holes. You will need to empty the drainage out of the bottom bin occasionally. Voila! Easy peasy!

*Liz Hardy*  
Earth Care Team

## First Round of Interviews Completed

The Call Committee has completed the Zoom interviews with the lead pastor candidates. It was truly an uplifting experience to speak with the candidates and learn about their ministry. After a week in prayer and discernment, we will determine which of the candidates we would like to meet in person to learn more about their gifts of ministry and how they would best meet the needs of St. Andrew and help us to achieve our vision for ministry.

We know you are anxious to hear more, but confidentiality is still required at this stage of the process. We will let you know when the in-person interviews are to occur once they are scheduled.

To learn more about the Call Process, consult the updated Call Process poster in the Narthex or ask a member of the Call Committee.

Please continue to hold the Call Committee, pastoral candidates, and the process in your prayers.

The Call Committee

*Steve Christiansen, Allison Katsufrakis, Mike McDowall, Amy McQueen, Tom Mehlhorn, Jan Smith, Mary Smith, LuAnn Staul*

## Da Jesus Book: Hawaii Pidgin New Testament

I loved this version so much that I bought another copy for the library. It's a refreshing translation, simply because it's not quite the English we know, and it puts things in a different perspective. You'll have to learn some Hawaiian to read it, but I'm sure you won't have much trouble. I didn't. Here's a sample:

God wen got so plenny love an aloha fo da peopo inside da world, dat wen he send me, his one an ony Boy, so dat everybody dat trus me no get cut off from God, but get da real kine life dat stay to da max foeva.

Amen.

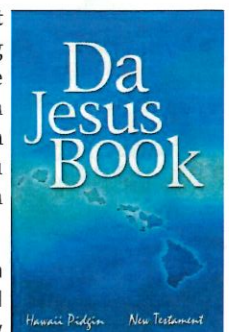

*Pam Farr*  
Adult Librarian

## 2023 Palm Sunday Bread for the World Letters to Congress

On Palm Sunday join St. Andrew members and people of faith throughout the U.S. in bearing witness to our concern for those who suffer from hunger by participating in the Bread for the World annual letter writing campaign. These letters inspire our leaders in Washington D.C. to enact policies and pass legislation that will reduce hunger and poverty in the U.S. and the world.

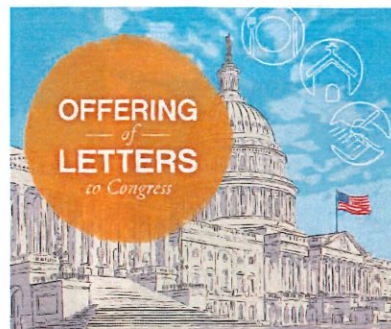

If you would like to get a head start, use the template on the reverse to get started.

Tips to make your request be the most successful:

- Ask for a specific action, using your own words or this sentence [I urge you to support a farm bill that builds healthy, equitable, and sustainable food systems].
- Give reasons for your request and make it personal; share a personal reason or story that motivated you to write.
- Show how St. Andrew is working to impact hunger: “My church, St. Andrew Lutheran in Beaverton Oregon, supports the St. Matthew Food Pantry with food and financial donations. I also urge you to protect the Supplemental Nutrition Assistance Program from cuts.”
- Write your name and address at the end of your letter and on the envelope, so your Congress members know you are one of their constituents.

It is even easier to send an email. You can find the email template on the Bread for the World [website](#). File your information and click on the text box to customize your email; the email letters will automatically be sent to your representative and senators.

Once you have submitted letters, please let me know who you sent letters/emails to so I can track this advocacy on the part of St. Andrew.

Yours in Christ,

LuAnn Staul

[ljstaul@gmail.com](mailto:ljstaul@gmail.com)

St. Andrew Service Committee

## Offering of Letters Sample

[Date]

Rep. Suzanne Bonamici  
2231 Rayburn HOB  
Washington, DC 20515



Senator Merkley  
313 Hart Senate Office Building  
Washington, DC 20510

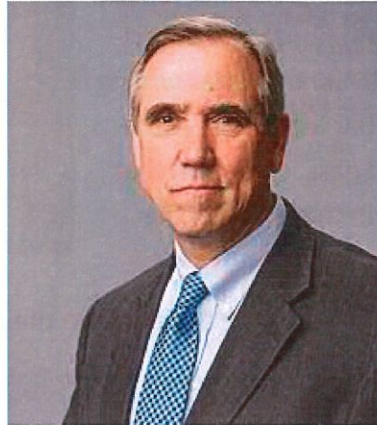

Senator Ron Wyden  
221 Dirksen Senate Office Building  
Washington, DC 20510



Dear Senator, / Dear Representative,

The farm bill is our nation's most important national food system legislation. It is critical to the work of ending hunger at home and abroad. Indeed, the farm bill impacts each one of us.

As Congress works to renew our food and farm programs through the farm bill, I urge you to support legislation that builds healthy, equitable, and sustainable food systems.

Specifically, I ask you to:

- Increase access to fresh fruits and vegetables by increasing support for produce-specific Supplemental Nutrition Assistance Program (SNAP) benefits in the Gus Schumacher Nutrition Incentive Program (GusNIP). This provides resources on top of monthly SNAP benefits for the purchase of fresh fruits and vegetables, primarily at farmers' markets, for a limited number of households.
- Eliminate barriers to SNAP for marginalized populations, including ending the ban on former drug offenders, eliminating work requirements for college students, and permitting indigenous communities to administer SNAP and other federal nutrition programs on reservations.
- Keep food out of landfills by increasing support for post-harvest food recovery efforts and addressing the threat to food security posed by extreme weather.
- Support funding for international food aid programs such as Food for Peace.

As a person of faith, I am moved to help and advocate for people experiencing hunger and poverty – no matter where they live. This is why I urge you to support a farm bill that builds healthy, equitable, and sustainable food systems.

Sincerely,

[Your name] [Your address]

## In Need of Prayers...

<u>NAME</u>	<u>PRAYERS FOR...</u>	<u>CONTACT</u>
Carol Hogan	Comfort and peace from fear, stress, and health issues	Staff
Rhonda Powell	Comfort, peace, and effective treatment	Staff
Marlene Maxwell	Comfort and peace on entering hospice	Sue Cahlander
Anne Newell	Comfort and peace while struggling with health concerns and testing	Anne Newell
Pam Cach (sister-in-law)	Comfort, strength, and peace	Dick & Francine Cach
Anne and family	Support for her and her family	Rebecca Uecker
Individual friends and loved ones	Whatever they need	Staff
All those who are caregivers for a loved one	Strength and support	Staff
Those confined to their homes	Assurance of God's presence	Staff
	Dave Bumgardner, Jean Fredrickson, Tara Harper, Marlene Maxwell, Dorothy Moore, Anne Newell, Ethel Ritchey, Helen Rogers, Sharon Roth	
Ecumenical Ministries of Oregon	Blessings on their work	Staff
Holy Trinity Catholic Church	Blessings on their work	Staff
St. Luke (Portland)	Serving with us in the Oregon Synod	Staff
The Flame (Portland)		
First (St. Helens)		
Ecumenical and interfaith partners in ministry	Blessings on their work	Staff

If you know someone in need of prayers, please contact the church office by phone at 503-646-0629, email [office@standrewlutheran.com](mailto:office@standrewlutheran.com), or fill out the prayer request form on the church website.

## Earth Camp 2024

Earth Camp returns this summer! This year's camp will take place **June 24-28**, and our theme will be *Home, Sweet Home*. Each day will focus on one of the many unique biomes we have in the beautiful state of Oregon. As a reminder, Earth Camp is for kids entering 1<sup>st</sup>-6<sup>th</sup> grades in the fall of 2024. Last year we had more than 40 campers and we hope to do that again this year! Registration for Earth Camp will open to St. Andrew folks on **Friday, April 5**, and will be open to all on **April 12** (one day before THPRD opens its summer camp registrations).

Lastly, it takes a village to make Earth Camp possible! Contact Director of Next Generational Ministry [Kyler Vogt](#) if you want to take part in this important event.

## Andy's Room Podcast: Holy Week Edition



### Holy Week

This week's episode of the Andy's Room Podcast is an Easter Special! Tune in to hear Kyler and Pastor Laurie talk through the days of Holy week and all the different ways they offer us meaning, connection, and hope. You can find this and other episodes by searching for the "Andy's Room Podcast" on Spotify or by following the link on the church website. Enjoy!



## Welcoming New Members

St. Andrew will be welcoming new members again in April. If you are interested in officially joining our faith community, it's not too late to be included. Please contact Pastor Laurie for more information.

Our church extends welcome to all, regardless of ethnicity, gender orientation, economic status, or any of the other societal constructs that aim to divide us. You don't need to be 100 percent confident in your faith and you don't need to be raised Lutheran. We embrace those who continue to question the mystery of faith. St. Andrew's values and mission align with people from many backgrounds. If you'd like to learn more, talk to Pastor Laurie or email her at [laurienewman@standrewlutheran.com](mailto:laurienewman@standrewlutheran.com).

## Your St. Andrew Staff

Council President Liz Hardy .....	president@standrewlutheran.com, 360-632-4900
Interim Pastor Laurie Newman.....	laurienewman@standrewlutheran.com
Sister India Jensen Kerr .....	india@standrewlutheran.com
Deacon Susan Reiser, Parish Musician and	
Interim Minister of Music.....	srwerner.reiser@standrewlutheran.com
Interim Keyboardist Lindsey Lane.....	503-646-0629
Dir. of Next Generational Ministry Kyler Vogt.....	kvogt@standrewlutheran.com
Parish Executive Carol Harker .....	charker@standrewlutheran.com
Administrative Assistant Rhonda Powell .....	office@standrewlutheran.com
Bookkeeper Karen Mallari .....	bookkeeper@standrewlutheran.com
Housekeeper Carol Hogan.....	503-646-0629
Evening Facility Caretaker Martin Mills .....	503-646-0629
Parish Nurses Diane Reiner .....	503-201-4222
Tira Nasset.....	503-866-5099

## Preparing for Worship

Palm Sunday  
March 24, 2024

Mark 11:1-11  
Philippians 2:5-11  
Mark 14:26-28

## Highlights for the Week at St. Andrew

### Sunday, March 17

9:30 am	In-Person Worship with Communion (also livestreamed and via Zoom)	Sanctuary
9:30 am	Portland Taiwan Worship Service	Chapel
10:45 am	Taiwan Lutheran Fellowship Gathering	Chapel
11:00 am	Adult Ed: Exile 101: Written in Babylon	Fellowship Hall
11:00 am	Adult Ed: The Theology and Poetry of Our Hymns	St. Andrew Room
11:00 am	Confirmation for Middle School Youth	Library
11:00 am	High School Youth Group	Youth Room
11:00 am	The Roots	Children's Commons, Children's Library, LL Classrooms
3:00 pm	Spirituality Book Group	Off Site

### Monday, March 18—Church Office Closed

7:00 pm	Finance Meeting	via Zoom
---------	-----------------	----------

### Tuesday, March 19

7:00 am	Men's Gathering and Bible Study	Elmer's Restaurant on 158 <sup>th</sup> (1250 NW Waterhouse Ave)
7:00 am	Sunrise Women	Elmer's Restaurant on 158 <sup>th</sup> (1250 NW Waterhouse Ave)
10:00 am	Tai Chi	Fellowship Hall
10:00 am	Worship Planners Meeting	Library
12:00 pm	Bridge Group	Fellowship Hall
6:30 pm	Scout Troop 198	Children's Commons
7:00 pm	Brass Quintet Rehearsal	Sanctuary

### Wednesday, March 20 Weekly News deadline is 4:00 pm; submit material to [office@standrewlutheran.com](mailto:office@standrewlutheran.com) and [charker@standrewlutheran.com](mailto:charker@standrewlutheran.com).

9:30 am	Apprentice Essentrics® Aging Backwards® workout class	Fellowship Hall
1:00 pm	Wednesday Book Group with Sister India	St. Andrew Room
6:00 pm	Bells of Grace Rehearsal	Sanctuary
6:00 pm	Treekeepers: Insect Pests that Bug Our Trees	Fellowship Hall
7:00 pm	Mid-Week Lent Service	Sanctuary
7:30 pm	Sanctuary Choir Rehearsal	Sanctuary

### Thursday, March 21

9:30 am	Seekers of the Heart of God Bible Study	St. Andrew Room
10:00 am	Strength and Stability with Susanne	Fellowship Hall
12:00 pm	Team Ministry Meeting	Chapel & Library
6:30 pm	Wing Chun Class	Children's Commons
7:00 pm	Council Meeting	Fellowship Hall & via Zoom

### Friday, March 22

10:00 am	Tai Chi	Fellowship Hall
----------	---------	-----------------

### Saturday, March 23

7:00 am	Tree Planting Event with Friends of Trees	Parking Lot
11:00 am	Brass Quintet Rehearsal	Sanctuary

### Sunday, March 24—Palm Sunday

9:30 am	In-Person Worship with Communion (also livestreamed and via Zoom)	Sanctuary
9:30 am	Portland Taiwan Worship Service	Chapel
10:45 am	Taiwan Lutheran Fellowship Gathering	Chapel
11:00 am	Bread for the World Offering of Letters	Fellowship Hall
1:00 pm	Twirler Meeting and Practice	Fellowship Hall



## Worship at St. Andrew or Connect to Virtual Worship

 **YouTube** **9:30 am:** Worship in the Sanctuary, watch the livestream of worship on YouTube, or participate in worship via Zoom. *Links for remote worship will be sent to you via email and the church app.*

 **zoom** People participating in worship via Zoom are invited to join worship at 9:30 am. To participate via Zoom, you may use a computer, smartphone, or tablet. Please note that Zoom worship is only available at 9:30 am.